

Prismenblöcke V-blocks

Prismenblöcke mit Spannbügel V-blocks with clamping bracket

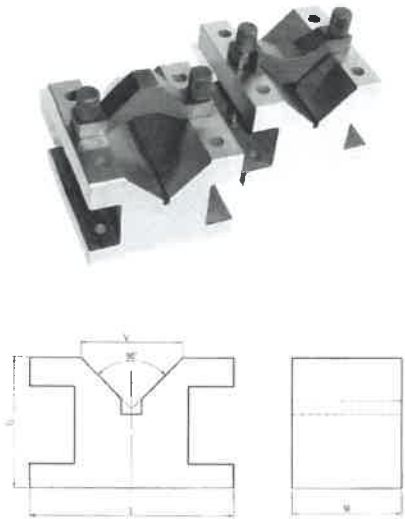

- geeignet zum Spannen von Rundmaterial
- 1 Prisma, 90°
- Spezialstahl gehärtet 52 - 58 HRC
- Parallelität: 0,005 / 100 mm
- Rechtwinkligkeit: 0,005 / 100 mm
- Lieferung paarweise

- suitable for clamping round material
- one V-groove 90°
- hardened special steel 52 - 58 HRC
- parallelism: 0,005 / 100 mm
- squareness: 0,005 / 100 mm
- delivered in pairs

L mm	W mm	H mm	V mm	Art.-Nr. / Order no.
35	35	30	11,5	14-PPSB-35
60	60	50	30	14-PPSB-60
75	100	75	60	14-PPSB-75
105	105	78	60	14-PPSB-105

Preis pro Paar / Price per pair

Prismenblöcke V-blocks

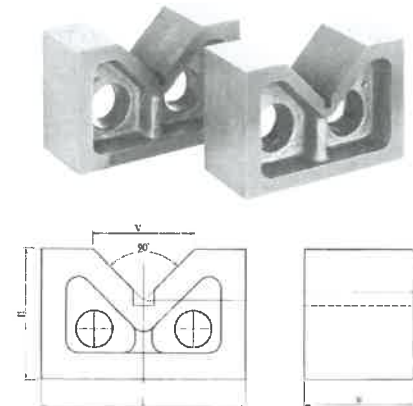

- aus Spezialguss
- prismatischer Einschnitt 90°
- Lieferung paarweise

- special cast iron
- V-groove 90°
- delivered in pairs

L mm	W mm	H mm	V mm	Art.-Nr. / Order no.
50	27	32	25	14-PP-50
76	35	61	44	14-PP-76
100	45	67	53	14-PP-100
130	51,5	79,5	64	14-PP-130
156	66	90,5	81	14-PP-156
181	77	110	85,4	14-PP-181
206	103	143	116	14-PP-206

Preis pro Paar / Price per pair

Prismenblöcke V-blocks

Prismenblöcke magnetisch, mit Schalter *Magnetic V-blocks, switchable*



- Paarweise bearbeitet
 - mit Schalter
 - gehärteter Stahl
 - 90° Prisma
 - Rechtwinkligkeit: 0,02 / 100 mm
 - Lieferung paarweise
- *machined in pairs*
 - *with switch*
 - *hardened steel*
 - *90° V-groove*
 - *squareness: 0,02 / 100 mm*
 - *delivered in pairs*

Größe / Size mm	Für / for Ø mm	Magnetkraft / Magnetic force kg	Art.-Nr. / Order no.
70 x 40 x 50	6-38	15	14-PPMS-70
100 x 50 x 80	6-44	20	14-PPMS-100
150 x 50 x 100	6-40	23	14-PPMS-150

Preis pro Paar / Price per set

Prismenblöcke V-blocks

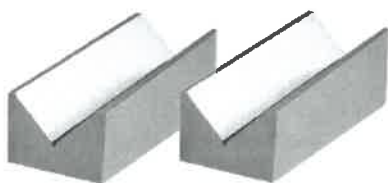

Prismenpaare V-block pairs

- paarweise geschliffen
- gehärteter Spezialstahl
- prismatischer Einschnitt 90°
- Lieferung paarweise
- machined in pairs
- hardened special steel
- V-groove 90°
- delivered in pairs

L x B x H / L x W x H mm	Güte / Grade	Für / for Ø mm	Genauigkeit / Accuracy mm	Art.-Nr. / Order no.
75 x 40 x 30	0	5-40	± 0,008	14-PBL-75/0
100 x 47 x 40	0	5-55	± 0,008	14-PBL-100/0
150 x 55 x 45	0	5-60	± 0,008	14-PBL-150/0
200 x 65 x 55	0	5-75	± 0,008	14-PBL-200/0
75 x 40 x 30	1	6-40	± 0,016	14-PBL-75/1
100 x 40 x 30	1	6-50	± 0,016	14-PBL-100/1
150 x 50 x 40	1	8-60	± 0,016	14-PBL-150/1
200 x 70 x 50	1	8-70	± 0,016	14-PBL-200/1
75 x 40 x 30	3	6-40	± 0,064	14-PBL-75/3
100 x 40 x 30	3	6-50	± 0,064	14-PBL-100/3
150 x 50 x 40	3	8-60	± 0,064	14-PBL-150/3
200 x 70 x 50	3	8-70	± 0,064	14-PBL-200/3

Preis pro Paar / Price per set

Winkelprismen Angle prisms

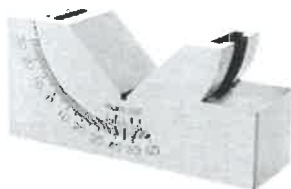

Winkelprismen, einstellbar Angle prisms, adjustable

- prismatischer Einschnitt 90°
- Stahl, 58 - 64 HRC
- Rechtwinkligkeit: ± 0,01 mm
- Winkel einstellbar von -30° bis +60°
- V-groove 90°
- high carbon steel, 58 - 64 HRC
- squareness: ± 0,01 mm
- angle adjustable from -30° to +60°

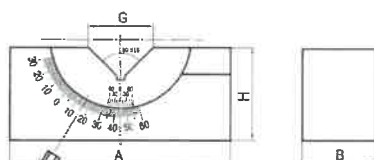

B mm	A mm	H mm	G mm	kg	Art.-Nr. / Order no.
25	75	33	25	0,5	14-WPE-25
30	102	30	46	1	14-WPE-30
46	102	46	46	1,5	14-WPE-46

Preis pro Stück / Price per piece

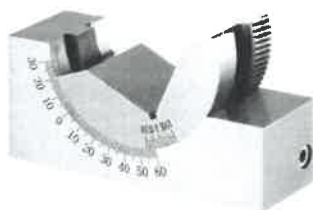

Winkelprismen, einstellbar mit Schneckengetriebe Angle prisms, adjustable by worm gear

- prismatischer Einschnitt 90°
- Stahl, 50 - 54 HRC
- Rechtwinkligkeit: ± 0,01 mm
- Winkel einstellbar von -30° bis +60° mit Schneckengetriebe
- V-groove 90°
- steel, 50 - 54 HRC
- squareness: ± 0,01 mm
- angle adjustable from -30° to +60° by worm gear

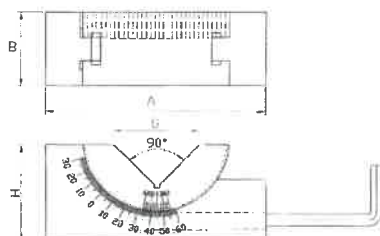

B mm	A mm	H mm	G mm	kg	Art.-Nr. / Order no.
25	75	32	29,5	0,5	14-WPESG-25
30	102	47	51,9	1	14-WPESG-30
46	102	47	53,4	1,4	14-WPESG-46

Preis pro Stück / Price per piece

Schraubböcke Leveling screws



Schraubböcke Leveling screws

Bereich / Range mm	D mm	C mm	kg	Art.-Nr. / Order no.
65-90	38	28,5	0,5	14-NVS-95
90-140	50	40	1,2	14-NVS-150
265-360	53	45	2,3	14-NVS-230
280-375	73	45	4,6	14-NVS-375

Preis pro Stück / Price per piece



Schraubböcke magnetisch Magnetic leveling screws

Bereich / Range mm	D mm	C mm	kg	Art.-Nr. / Order no.
42-47	40	35	0,4	14-NVSM-50
51-65	40	35	0,5	14-NVSM-65
67-87	45	40	0,7	14-NVSM-85
86-116	45	40	0,7	14-NVSM-110
110-170	50	45	1,4	14-NVSM-165

Preis pro Stück / Price per piece