

Angetriebene Werkzeuge

Driven tools

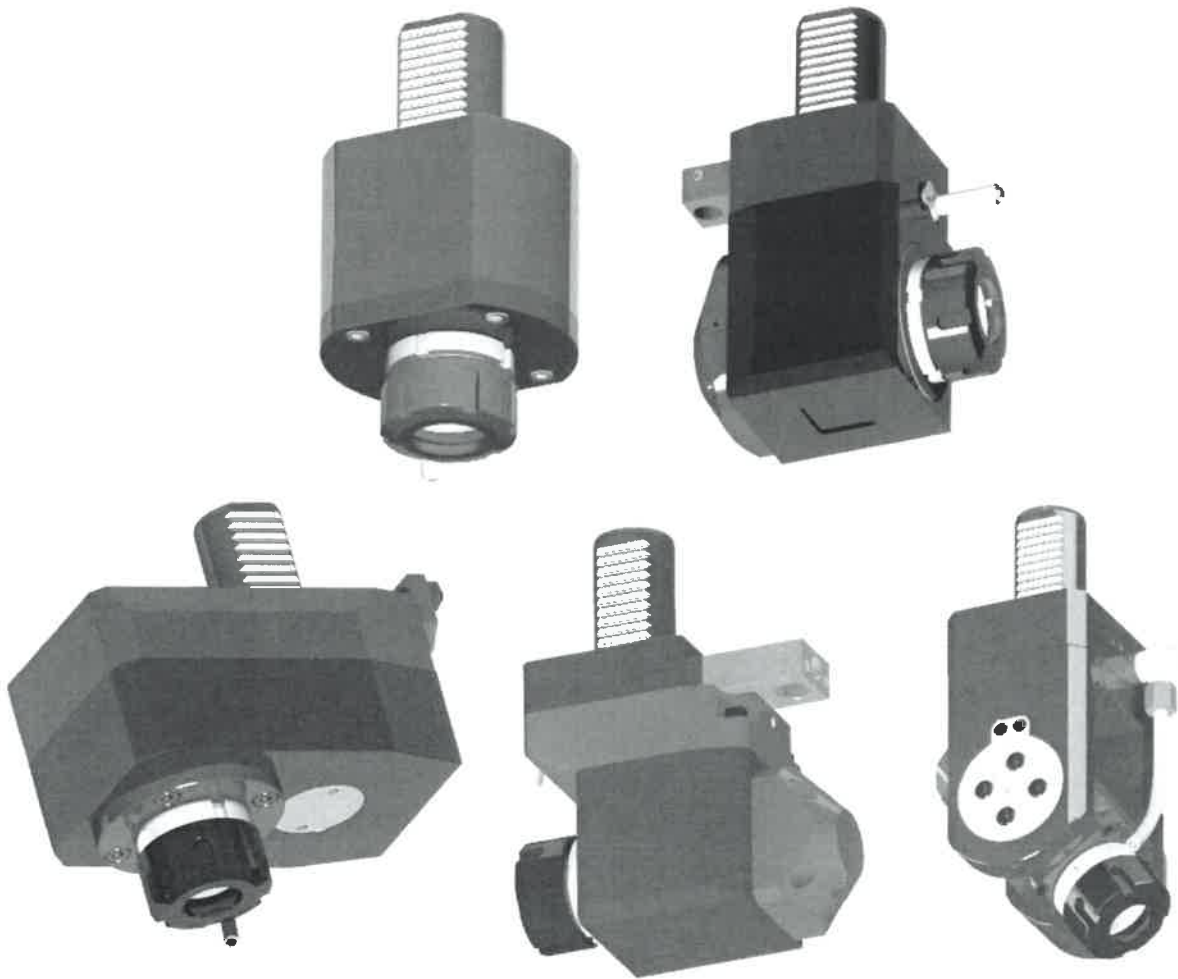

■ Inhalt:

- | DIN 5480 - für SAUTER Revolver
- | DIN 5482 - für SAUTER Revolver
- | TOEM - für BARRUFALDI Revolver
- | Befestigung mit Schrauben -
für MORI SEIKI Revolver
- | Befestigung mit Schrauben -
für NAKAMURA Revolver

■ Content:

- | *DIN 5480 - for SAUTER turrets*
- | *DIN 5482 - for SAUTER turrets*
- | *TOEM - for BARRUFALDI turrets*
- | *Mounted by bolts -
for MORI SEIKI turrets*
- | *Mounted by bolts -
for NAKAMURA turrets*

Angetriebene Werkzeuge - DIN 5480 - für SAUTER Revolver

Driven tools - DIN 5480 - for SAUTER turrets



Angetriebene Werkzeuge - DIN 5480

Driven tools - DIN 5480

- Kühlmitteldruck bis 20 bar
- gekapselte Präzisionslager
- geeignet für hohe Drehzahlen
- geeignet für Rechts- und Linkslauf
- coolant pressure up to 20 bar
- high-precision capsulated bearings
- suitable for high spindle speeds
- suitable for right and left-hand rotation



DIN 5480, gerade

DIN 5480, straight

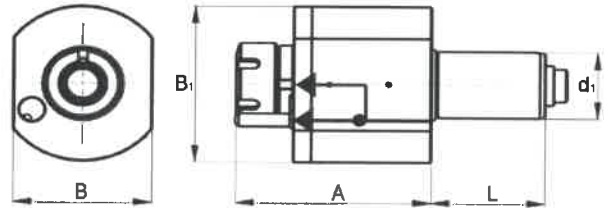

d1	SZ / Collet	IK / IC	A mm	L mm	B mm	B1 mm	Übersetzung / Ratio	Max. Drehmoment / Max. torque Nm	Drehzahl / Speed min-1	Art.-Nr. / Order no.
VDI 30	ER 25	-	87	55	62	69	1 : 1	28	6000	▶ 47-80-G-30-25
VDI 30	ER 25	✓	87	55	62	69	1 : 1	28	6000	▶ 47-80-G-30-25IK
VDI 40	ER 25	-	120	63	76	94	1 : 1	50	6000	▶ 47-80-G-40-25
VDI 40	ER 25	✓	120	63	76	94	1 : 1	50	6000	▶ 47-80-G-40-25IK
VDI 40	ER 32	-	120	63	76	94	1 : 1	50	6000	▶ 47-80-G-40-32
VDI 40	ER 32	✓	120	63	76	94	1 : 1	50	6000	▶ 47-80-G-40-32IK



DIN 5480, abgewinkelt 90°

DIN 5480, angular 90°

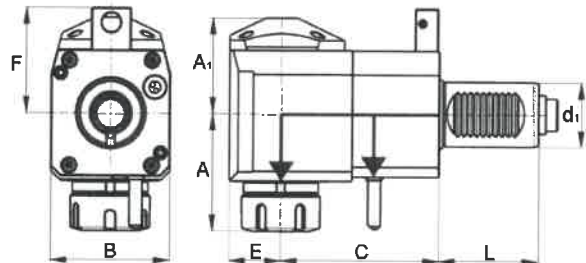

d1	SZ / Collet	IK / IC	Richtung / Direction	C mm	A1 mm	A mm	L mm	F mm	E mm	B mm	Übersetzung / Ratio	Max. Drehmoment / Max. torque Nm	Drehzahl / Speed min-1	Art.-Nr. / Order no.
VDI 30	ER 25	-	rechts/right	55	48	63	55	56	26	64	1 : 1	28	6000	▶ 47-80-WKR-30-25
VDI 30	ER 25	✓	rechts/right	55	51	63	55	56	26	64	1 : 1	28	6000	▶ 47-80-WKR-30-25IK
VDI 30	ER 25	-	rechts/right	85	48	63	55	56	26	64	1 : 1	28	6000	▶ 47-80-WR-30-25
VDI 30	ER 25	✓	rechts/right	85	51	63	55	56	26	64	1 : 1	28	6000	▶ 47-80-WR-30-25IK
VDI 40	ER 32	-	rechts/right	80	59	74	63	65	33	75	1 : 1	50	6000	▶ 47-80-WKR-40-32
VDI 40	ER 32	✓	rechts/right	80	62	74	63	65	33	75	1 : 1	50	6000	▶ 47-80-WKR-40-32IK
VDI 40	ER 32	-	rechts/right	100	59	74	63	65	33	75	1 : 1	50	6000	▶ 47-80-WR-40-32
VDI 40	ER 32	✓	rechts/right	100	62	74	63	65	33	75	1 : 1	50	6000	▶ 47-80-WR-40-32IK

Angetriebene Werkzeuge - DIN 5480 - für SAUTER Revolver

Driven tools - DIN 5480 - for SAUTER turrets



DIN 5480
gerade, versetzt
DIN 5480
straight, offset

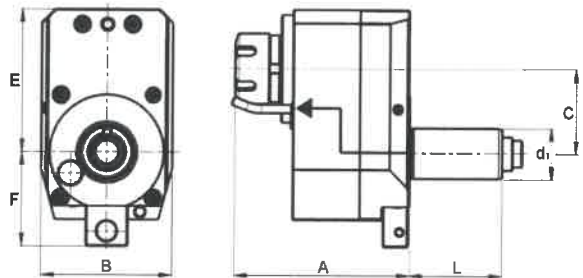

d1	SZ / Collet	IK / IC	Richtung / Direction	C mm	A mm	L mm	F mm	E mm	B mm	Übersetzung / Ratio	Max. Drehmoment / Max. torque Nm	Drehzahl / Speed min-1	Art.-Nr. / Order no.
VDI 30	ER 25	-	rechts/right	50	105	55	56	85	78	1 : 2	14	12000	47-80-GV-30-25



DIN 5480
abgewinkelt 90°,
zurückgesetzt
DIN 5480
angular 90°,
offset

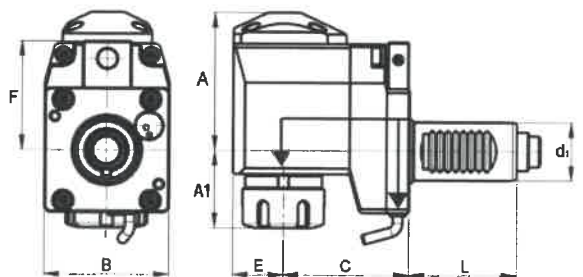

d1	SZ / Collet	IK / IC	Richtung / Direction	C mm	A mm	A1 mm	L mm	F mm	E mm	B mm	Übersetzung / Ratio	Max. Drehmoment / Max. torque Nm	Drehzahl / Speed min-1	Art.-Nr. / Order no.
VDI 30	ER 25	-	rechts/right	75	71	40	55	56	26	64	1 : 1	28	6000	47-80-WVR-30-25
VDI 30	ER 25	✓	rechts/right	75	74	40	55	56	26	64	1 : 1	28	6000	47-80-WVR-30-25IK



DIN 5480,
verstellbar 0° bis ±105°
DIN 5480,
adjustable 0° to ±105°

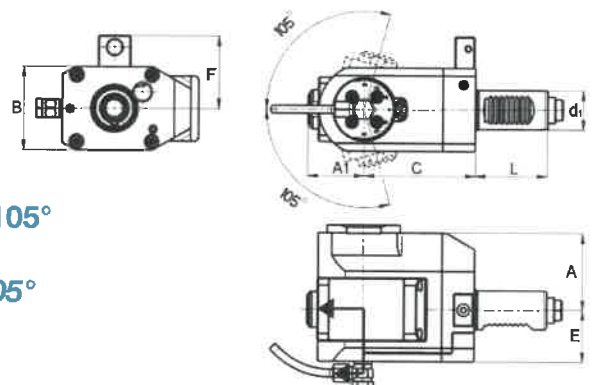

d1	SZ / Collet	IK / IC	C mm	A mm	A1 mm	L mm	F mm	E mm	B mm	Übersetzung / Ratio	Max. Drehmoment / Max. torque Nm	Drehzahl / Speed min-1	Art.-Nr. / Order no.
VDI 30	ER 16	✓	86	65	43	55	56	40	64	1 : 1	16	6000	47-80-E-30-16IK

Angetriebene Werkzeuge - DIN 5482 - für SAUTER Revolver

Driven tools - DIN 5482- for SAUTER turrets



Angetriebene Werkzeuge - DIN 5482

Driven tools - DIN 5482

- Kühlmitteldruck bis 20 bar
- gekapselte Präzisionslager
- geeignet für hohe Drehzahlen
- geeignet für Rechts- und Linkslauf
- coolant pressure up to 20 bar
- high-precision capsulated bearings
- suitable for high spindle speeds
- suitable for right and left-hand rotation



DIN 5482, gerade

DIN 5482, straight

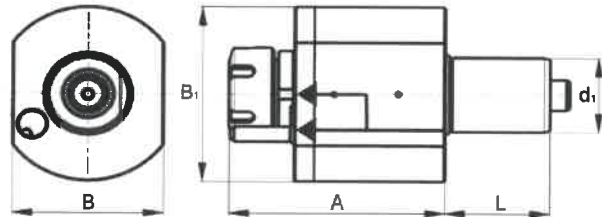

d1	SZ / Collet	IK / IC	A mm	L mm	B mm	B1 mm	Übersetzung / Ratio	Max. Drehmoment / Max. torque Nm	Drehzahl / Speed min-1	Art.-Nr. / Order no.
VDI 30	ER 25	-	87	45	62	69	1 : 1	28	6000	▶ 47-82-G-30-25
VDI 30	ER 25	✓	87	45	62	69	1 : 1	28	6000	▶ 47-82-G-30-25IK
VDI 40	ER 25	-	105	53	76	94	1 : 1	50	6000	▶ 47-82-G-40-25
VDI 40	ER 25	✓	105	53	76	94	1 : 1	50	6000	▶ 47-82-G-40-25IK
VDI 40	ER 32	-	108	53	76	94	1 : 1	50	6000	▶ 47-82-G-40-32
VDI 40	ER 32	✓	108	53	76	94	1 : 1	50	6000	▶ 47-82-G-40-32IK



DIN 5482, abgewinkelt 90°

DIN 5482, angular 90°

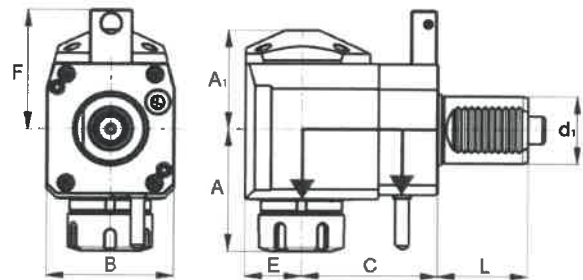

d1	SZ / Collet	IK / IC	Richtung / Direction	C mm	A1 mm	A mm	L mm	F mm	E mm	B mm	Übersetzung / Ratio	Max. Drehmoment / Max. torque Nm	Drehzahl / Speed min-1	Art.-Nr. / Order no.
VDI 30	ER 25	-	rechts/right	55	48	63	45	48	26	64	1 : 1	28	6000	▶ 47-82-WR-30-25
VDI 30	ER 25	✓	rechts/right	55	51	63	45	48	26	64	1 : 1	28	6000	▶ 47-82-WR-30-25IK
VDI 40	ER 25	-	rechts/right	80	59	70	53	71	33	75	1 : 1	50	6000	▶ 47-82-WR-40-25
VDI 40	ER 25	✓	rechts/right	80	62	70	53	71	33	75	1 : 1	50	6000	▶ 47-82-WR-40-25IK
VDI 40	ER 32	-	rechts/right	80	59	74	53	71	33	75	1 : 1	50	6000	▶ 47-82-WR-40-32
VDI 40	ER 32	✓	rechts/right	80	62	74	53	71	33	75	1 : 1	50	6000	▶ 47-82-WR-40-32IK
VDI 40	ER 25	-	links/left	80	59	70	53	71	33	75	1 : 1	50	6000	▶ 47-82-WL-40-25
VDI 40	ER 25	✓	links/left	80	62	70	53	71	33	75	1 : 1	50	6000	▶ 47-82-WL-40-25IK
VDI 40	ER 32	-	links/left	80	59	74	53	71	33	75	1 : 1	50	6000	▶ 47-82-WL-40-32
VDI 40	ER 32	✓	links/left	80	62	74	53	71	33	75	1 : 1	50	6000	▶ 47-82-WL-40-32IK

Angetriebene Werkzeuge - DIN 5482 - für SAUTER Revolver Driven tools - DIN 5482- for SAUTER turrets



DIN 5482
gerade, versetzt
DIN 5482
straight, offset

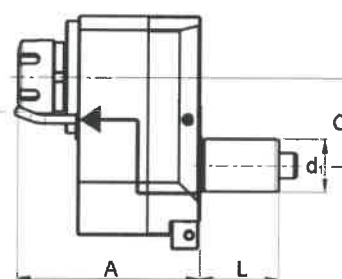
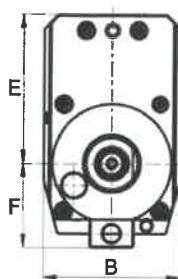

d1	SZ / Collet	IK / IC	Richtung / Direction	C mm	A mm	L mm	F mm	E mm	B mm	Übersetzung / Ratio	Max. Drehmoment / Max. torque Nm	Drehzahl / Speed min-1	Art.-Nr. / Order no.
VDI 30	ER 25	-	rechts/right	50	105	45	48	85	78	1 : 2	14	12000	47-82-GV-30-25



DIN 5482
abgewinkelt 90°,
zurückgesetzt
DIN 5482
angular 90°,
offset

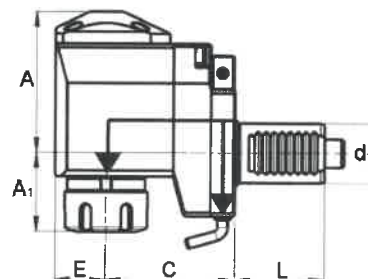
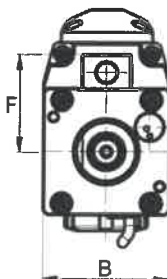

d1	SZ / Collet	IK / IC	Richtung / Direction	C mm	A mm	A1 mm	L mm	F mm	E mm	B mm	Übersetzung / Ratio	Max. Drehmoment / Max. torque Nm	Drehzahl / Speed min-1	Art.-Nr. / Order no.
VDI 30	ER 25	-	rechts/right	75	71	40	45	48	26	64	1 : 1	28	6000	47-82-WVR-30-25
VDI 30	ER 25	✓	rechts/right	75	74	40	45	48	26	64	1 : 1	28	6000	47-82-WVR-30-25IK



DIN 5482,
verstellbar 0° bis ±105°
DIN 5482,
adjustable 0° to ±105°

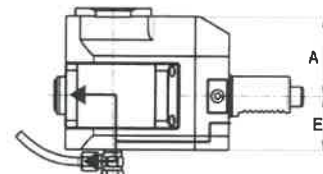
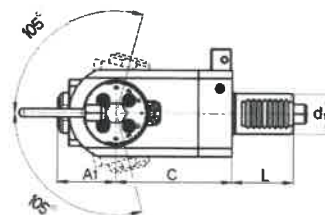

d1	SZ / Collet	IK / IC	C mm	A mm	A1 mm	L mm	F mm	E mm	B mm	Übersetzung / Ratio	Max. Drehmoment / Max. torque Nm	Drehzahl / Speed min-1	Art.-Nr. / Order no.
VDI 30	ER 16	✓	86	65	43	45	48	40	64	1 : 1	16	6000	47-82-E-30-16IK

Passende Sicherheitsschlüssel FR siehe Seite 259 / Suitable safety-spanners FR see page 259

Angetriebene Werkzeuge - TOEM - für BARRUFALDI Revolver

Driven tools - TOEM - for BARRUFALDI turrets



Angetriebene Werkzeuge - TOEM

Driven tools - TOEM

- Kühlmitteldruck bis 20 bar
- gekapselte Präzisionslager
- geeignet für hohe Drehzahlen
- geeignet für Rechts- und Linkslauf
- coolant pressure up to 20 bar
- high-precision capsulated bearings
- suitable for high spindle speeds
- suitable for right and left-hand rotation



TOEM, gerade

TOEM, straight

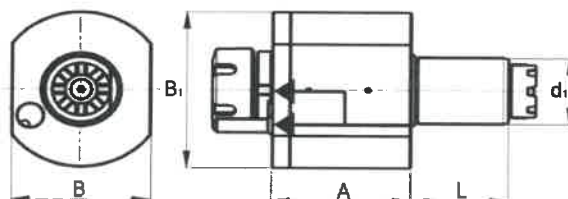

d1	SZ / Collet	IK / IC	A mm	L mm	B mm	B1 mm	Übersetzung / Ratio	Max. Drehmoment / Max. torque Nm	Drehzahl / Speed min-1	Art.-Nr. / Order no.
VDI 30	ER 25	-	87	45	62	69	1 : 1	28	6000	▶ 47-TO-G-30-25
VDI 30	ER 25	✓	87	45	62	69	1 : 1	28	6000	▶ 47-TO-G-30-25IK
VDI 40	ER 25	-	105	53	76	94	1 : 1	50	6000	▶ 47-TO-G-40-25
VDI 40	ER 25	✓	105	53	76	94	1 : 1	50	6000	▶ 47-TO-G-40-25IK
VDI 40	ER 32	-	108	53	76	94	1 : 1	50	6000	▶ 47-TO-G-40-32
VDI 40	ER 32	✓	108	53	76	94	1 : 1	50	6000	▶ 47-TO-G-40-32IK



TOEM, abgewinkelt 90°

TOEM, angular 90°

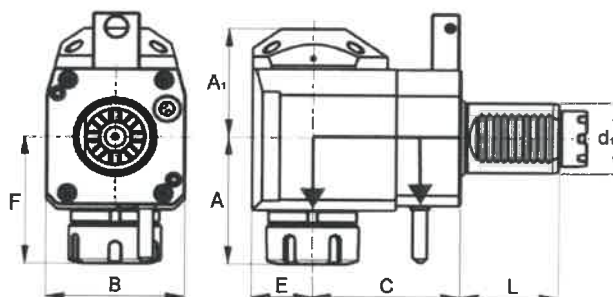

d1	SZ / Collet	IK / IC	Richtung / Direction	C mm	A1 mm	A mm	L mm	F mm	E mm	B mm	Übersetzung / Ratio	Max. Drehmoment / Max. torque Nm	Drehzahl / Speed min-1	Art.-Nr. / Order no.
VDI 30	ER 25	-	rechts/right	55	48	63	45	48	26	64	1 : 1	28	6000	▶ 47-TO-WR-30-25
VDI 30	ER 25	✓	rechts/right	55	51	63	45	48	26	64	1 : 1	28	6000	▶ 47-TO-WR-30-25IK

Angetriebene Werkzeuge - Befestigung mit Schrauben - für MORI SEIKI Revolver Driven tools - Mounted by bolts - for MORI SEIKI turrets

Angetriebene Werkzeuge - Befestigung mit Schrauben Driven tools - Mounted by bolts

- Kühlmitteldruck bis 20 bar
- gekapselte Präzisionslager
- geeignet für hohe Drehzahlen
- geeignet für Rechts- und Linkslauf
- coolant pressure up to 20 bar
- high-precision capsulated bearings
- suitable for high spindle speeds
- suitable for right and left-hand rotation

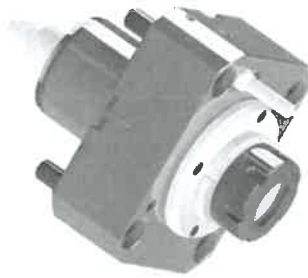

**Gerade
Straight**

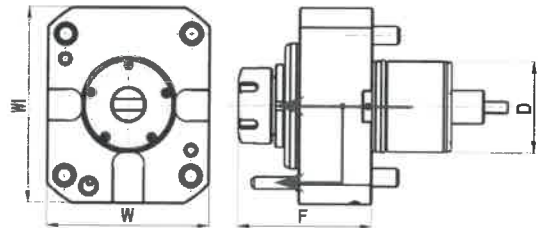

D	SZ / Collet	IK / IC	F mm	W mm	W1 mm	Übersetzung / Ratio	Max. Drehmoment / Max. torque Nm	Drehzahl / Speed min-1	Art.-Nr. / Order no.
45	ER 25	-	86	75	75	1 : 1	28	6000	▶ 47-MO-G-45-25
45	ER 25	✓	86	75	75	1 : 1	28	6000	▶ 47-MO-G-45-25IK
60	ER 32	-	89	108	130	1 : 1	70	6000	▶ 47-MO-G-60-32
60	ER 32	✓	89	108	130	1 : 1	70	6000	▶ 47-MO-G-60-32IK



**Abgewinkelt 90°
Angular 90°**

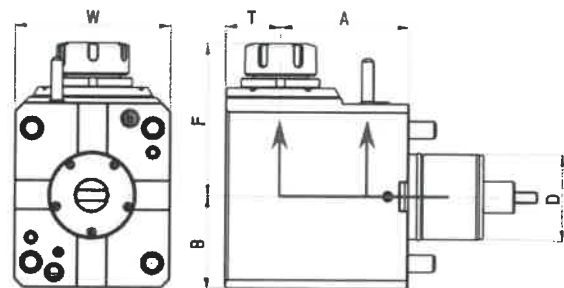

D	SZ / Collet	IK / IC	A mm	B mm	F mm	T mm	W mm	Übersetzung / Ratio	Max. Drehmoment / Max. torque Nm	Drehzahl / Speed min-1	Art.-Nr. / Order no.
60	ER 32	-	90	65	107	38	108	1 : 1	70	6000	▶ 47-MO-WR-60-32
60	ER 32	✓	90	65	107	38	108	1 : 1	70	6000	▶ 47-MO-WR-60-32IK

Angetriebene Werkzeuge - Befestigung mit Schrauben
- für NAKAMURA Revolver
Driven tools - Mounted by bolts - for NAKAMURA turrets

Angetriebene Werkzeuge - Befestigung mit Schrauben
Driven tools - Mounted by bolts

- Kühlmitteldruck bis 20 bar
- gekapselte Präzisionslager
- geeignet für hohe Drehzahlen
- geeignet für Rechts- und Linkslauf
- coolant pressure up to 20 bar
- high-precision capsulated bearings
- suitable for high spindle speeds
- suitable for right and left-hand rotation



Gerade
Straight

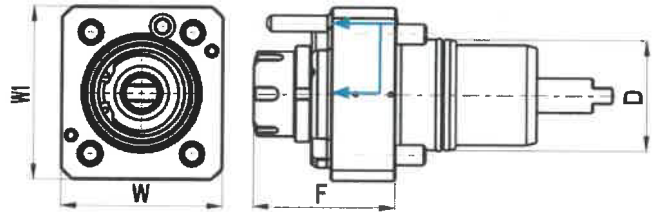

D	SZ / Collet	IK / IC	F mm	W mm	W1 mm	Übersetzung / Ratio	Max. Drehmoment / Max. torque Nm	Drehzahl / Speed min-1	Art.-Nr. / Order no.
55	ER 25	-	71	80	86	1 : 1	28	6000	▶ 47-NA-G-55-25
55	ER 25	✓	71	80	86	1 : 1	28	6000	▶ 47-NA-G-55-25IK
65	ER 32	-	75	96	96	1 : 1	50	6000	▶ 47-NA-G-65-32
65	ER 32	✓	75	96	96	1 : 1	50	6000	▶ 47-NA-G-65-32IK



Abgewinkelt 90°
Angular 90°

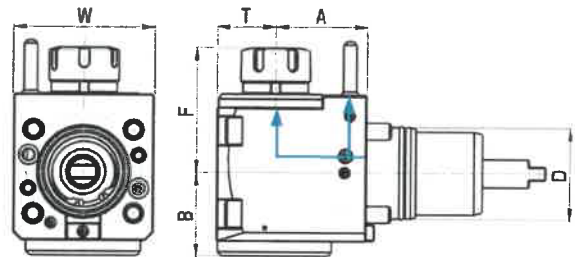

d1	SZ / Collet	IK / IC	A mm	B mm	F mm	T mm	W mm	Übersetzung / Ratio	Max. Drehmoment / Max. torque Nm	Drehzahl / Speed min-1	Art.-Nr. / Order no.
55	ER 25	-	55	50,3	74,8	35	84	1 : 1	28	6000	▶ 47-NA-WR-55-25
55	ER 25	✓	55	50,3	74,8	35	84	1 : 1	28	6000	▶ 47-NA-WR-55-25IK
65	ER 32	-	65	59	110	38	96	1 : 1	50	6000	▶ 47-NA-WR-65-32
65	ER 32	✓	65	59	110	38	96	1 : 1	50	6000	▶ 47-NA-WR-65-32IK

