

**STRUMENTI
ZOP**

AZZERATORE MAGNETICO LUMINOSO
BRIGHT MAGNETIC RESETTER

BATTERY



TIPO	Art.	
ZOP 50	0351	0266

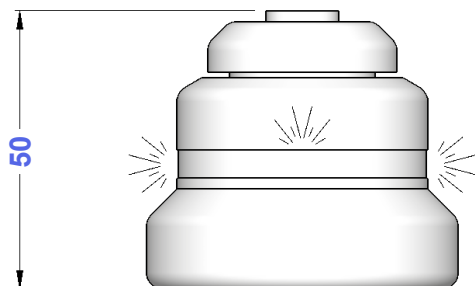

**STRUMENTI
ZDI**

AZZERATORI MAGNETICI CON COMPARATORE
BUILD-IN MAGNETIC RESETTERS WITH COMPARATOR

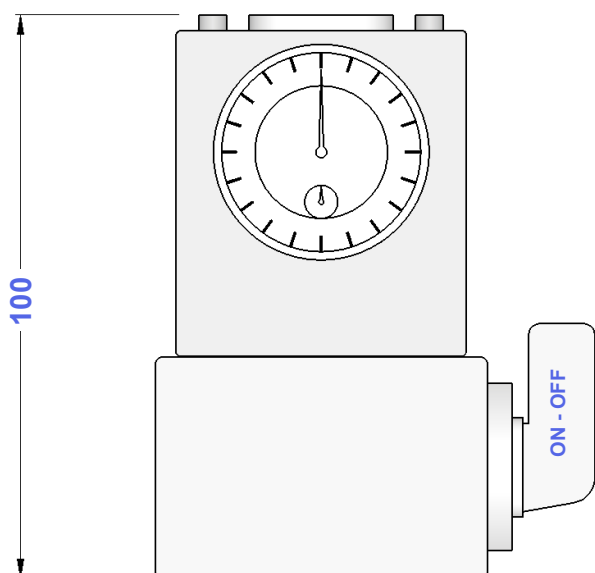

TIPO	Art.
ZDI 100	0354

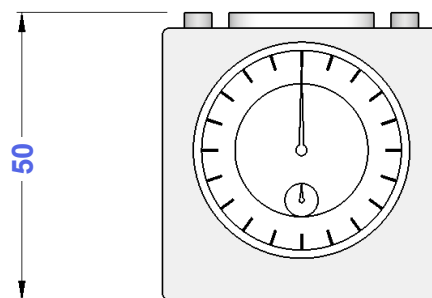

TIPO	Art.
ZDI 50	0349

STRUMENTI CMP

CENTRATORI MECCANICI FLOTTANTI FLOATING POSITION DETECTORS

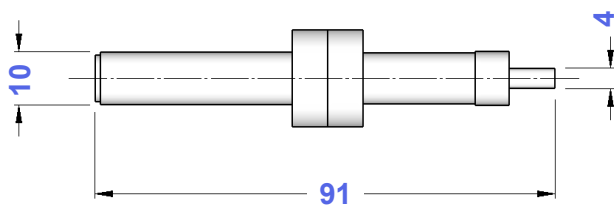

TIPO	Art.	
CMP 10 - 4	0356	0333

Nella confezione dei CMP è compresa una molla di ricambio
In CMP wrapping is included one spare spring

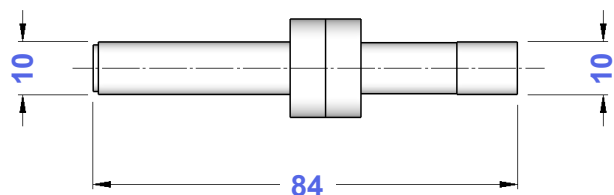

TIPO	Art.	
CMP 10 - 10	0357	0333

STRUMENTI CMA

CENTRATORI MECCANICI FLOTTANTI ANTIMAGNETICI ANTIMAGNETIC FLOATING POSITION DETECTORS

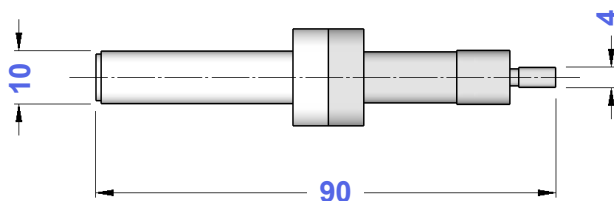

TIPO	Art.	
CMA 10 - 4	0445	0444

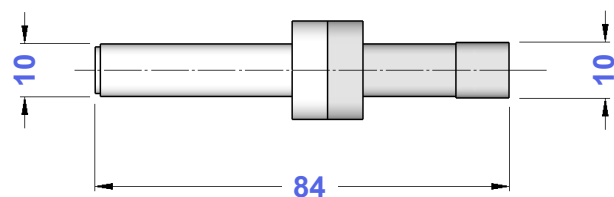

TIPO	Art.	
CMA 10 - 10	0447	0444

STRUMENTI CMC

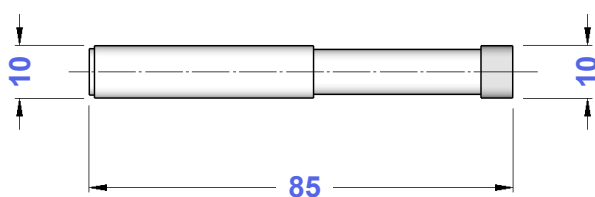

CENTRATORE MECCANICO FLOTTANTE ANTIMAGNETICO CON TESTINA CERAMICA ANTIMAGNETIC FLOATING POSITION DETECTOR WITH EARTHENWARE HEAD



TIPO	Art.	
CMC 10 - 10	0457	0458

**STRUMENTI
CSL**

CENTRATORI A SFERA LUMINOSI
BRIGHT ELECTRONIC POSITION DETECTORS

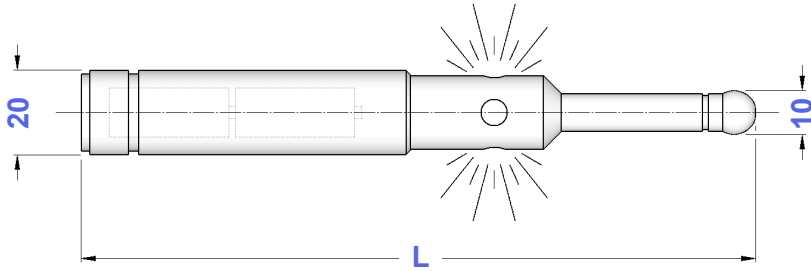

SPHERE	LED	BATTERY
		

TIPO	Art.	L	SPHERE	LED	BATTERY
CSL 125	0355	125	0587	0545	0562
CSL 160	0358	160	0587	0545	0562



**STRUMENTI
ES**

CENTRATORE A SFERA LUMINOSO E SONORO
BRIGHT-SONOROUS ELECTRONIC POSITION DETECTOR

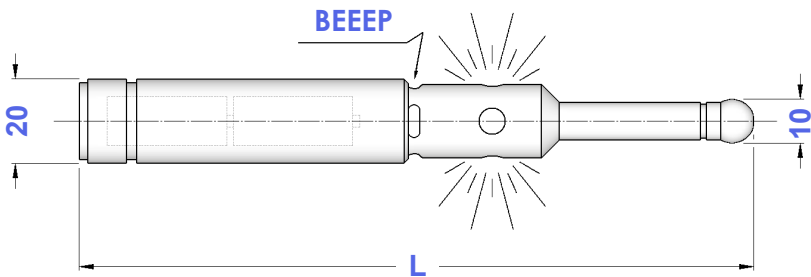

SPHERE	LED	BATTERY
		

TIPO	Art.	L	SPHERE	LED	BATTERY
ES 20 - 10	0359	160	0587	0549	0562



**STRUMENTI
CTL**

CENTRATORE 3D LUMINOSO E SONORO
BRIGHT-SONOROUS 3D ELECTRONIC POSITION DETECTOR

TASTER	LED	BATTERY
		

TIPO	Art.	TASTER	LED	BATTERY
CTL 20 - 6	0350	0322	0328	0595

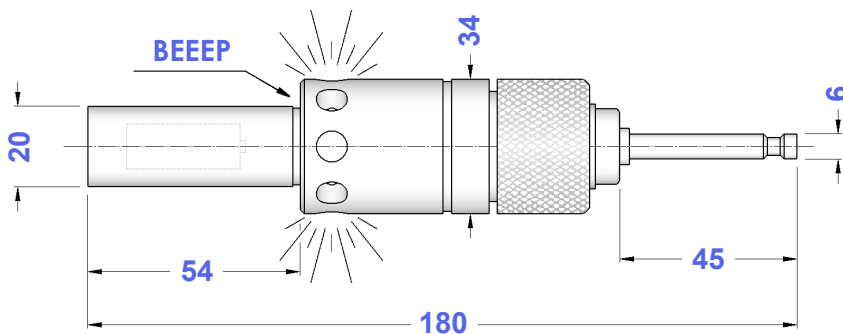

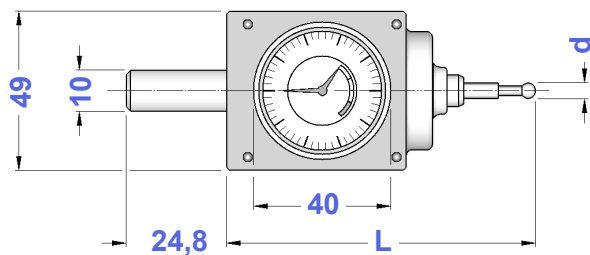

ATTACCO D.10
D.10 SHANK

TIPO	Art.	d	L	
CTZ 10 - 04	0541	4	96	0619
CTZ 10 - 08	0542	8	136	0629

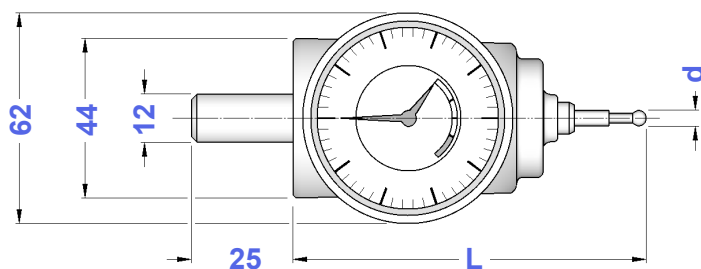

ATTACCO D.12
D.12 SHANK

TIPO	Art.	d	L	
CTN 12 - 04	0543	4	100	0619
CTN 12 - 08	0544	8	140	0629

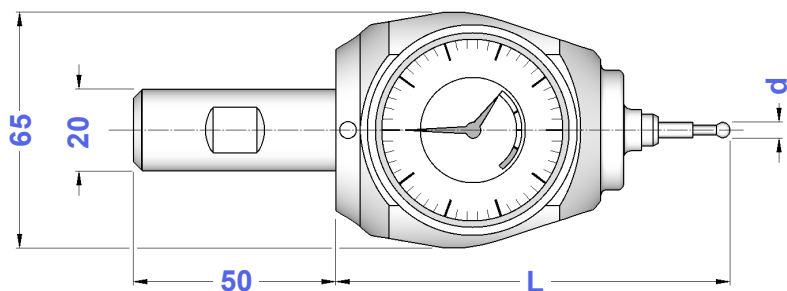

ATTACCO D.20
D.20 SHANK

TIPO	Art.	d	L	
CTA 20 - 04	0584	4	113	0619
CTA 20 - 08	0585	8	153	0629

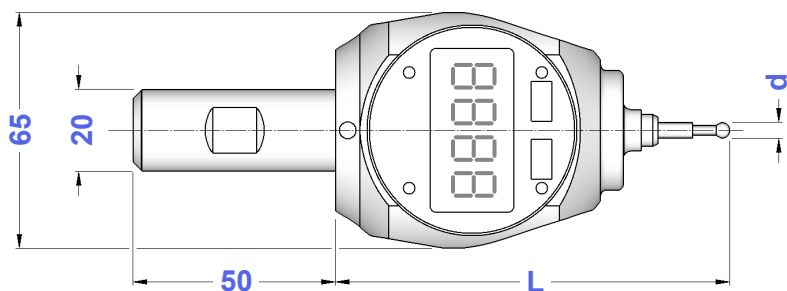

DIGITALE - ATTACCO D.20
DIGITAL - D.20 SHANK

TIPO	Art.	d	L	
CTD 20 - 04	0581	4	113	0619
CTD 20 - 08	0582	8	153	0629

ASTINE CERAMICHE
EARTHENWARE TASTERS

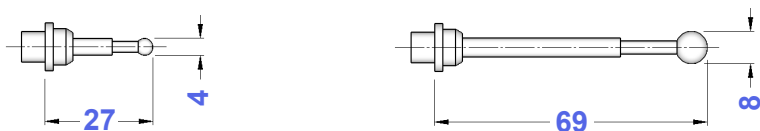

TIPO	Art.
ASTINA CORTA d. 4	0619
ASTINA LUNGA d. 8	0629